

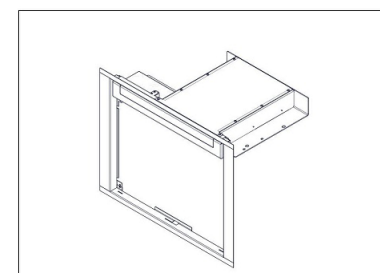

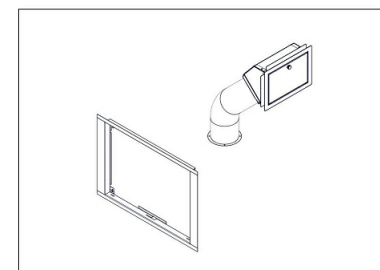

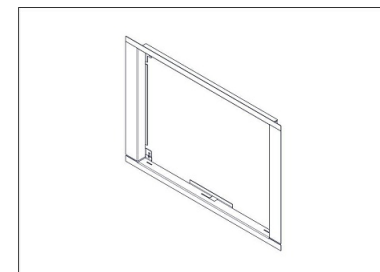

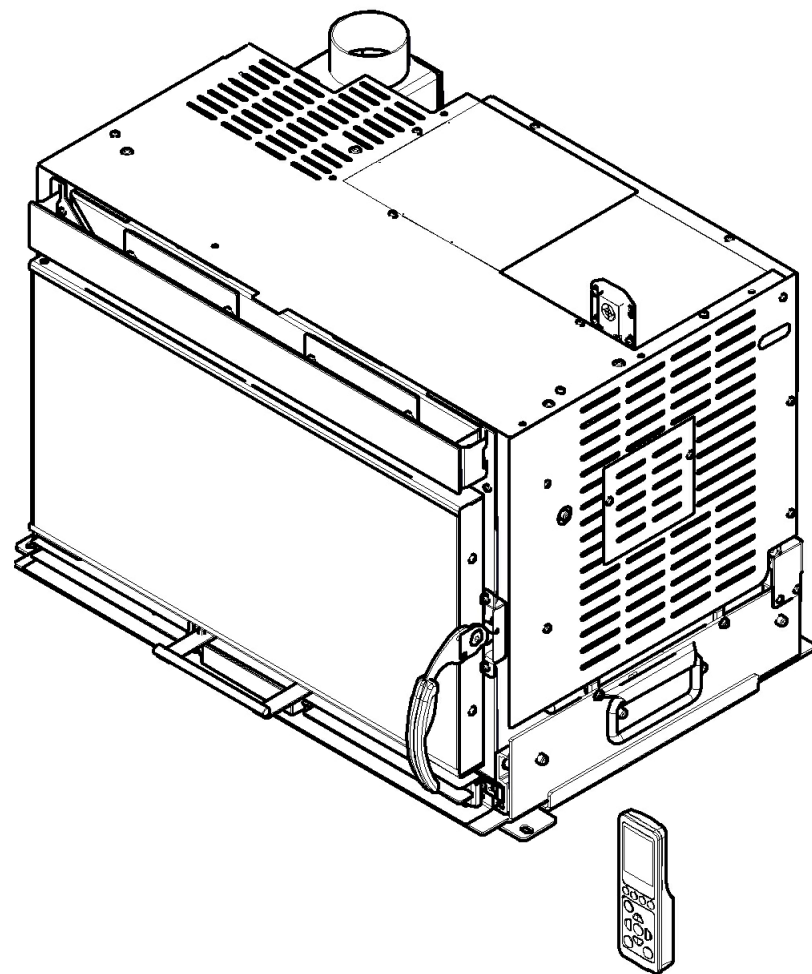

































PELLKAMIN EVO 8























PELLKAMIN EVO 8

HotSpot ↑↓	Basket Code ↑↓	Description	↑↓ Unité de mesure	Price €	Image	Note fra 2
0	 R1003530	PK EVO DEFLECT. VENTIL.DROIT	NR	4,94		
77	 R1004610	JOINT.CARTE C.E.TYPE 3 PELLKAM	NR	1,50		
9	 R1004850	ENS POIGNEE EXTRACTION INSERT	NR	9,66		
0	 R1004930	PK EVO FERMETURE COTE GAUCHE	NR	3,06		
14	 R1005290	GLISSIERE PELLKAMIN	NR	156,00		
78	 R1006320	PELLKAMIN GRILLE	NR	30,24		
15	 R1006460	PLAQUE BASE SOUDEE	NR	120,00		
0	 R1006620	PK EVO SUPPORT FIXATION FLANC	NR	3,11		
18	 R1006760	CHARGEUR AVEC VIS S FIN	NR	83,20		
0	 R1008023	PK EVO DEFLECTEUR AIRE SUPER.	NR	4,35		
0	 R1008920	PELLKAMIN DEFLECTEUR INOX	NR	46,80		
0	 R1008950	PELLKAMIN PAROI CMB SUPP.INBOX	NR	31,20		
0	 R1008960	PELLKAMIN-INTERNE CHAMBRE COMB	NR	5,20		
83	 R1008970	PK EVO PLAQUE INSPEC.ECHANGEUR	NR	3,95		
82	 R1008980	PK EVO PLAQUE INSPEC.ECHANGEUR	NR	3,35		
81	 R1008990	PK EVO PLAQUE INSPEC.ECHANGEUR	NR	1,79		
0	 R1009000	PK EVO FERM.CHARGEUR PELLET	NR	1,76		
4	 R1009020	PELLKAMIN BAC A CENDRE GAUCHE	NR	20,80		
5	 R1009040	PELLKAMIN BAC A CENDRE DROIT	NR	20,80		
84	 R1009090	JOINT.CARTE C.E ALLUM.PELLKAM	NR	2,08		





















PELLKAMIN EVO 8

HotSpot ↑↓	Basket Code ↑↓	Description	↑↓ Unité de mesure	Price €	Image	Note fra 2
85		R1010000 JOINT. CARTE C.E. PELLKAMIN	NR	3,00		
0		R1010160 PELLKAMIN PIVOT OUVERTURE	NR	3,12		
0		R1010750 ENTREE AIR COMBUSTION ASSEMB	NR	8,00		
0		R1010760 PLAQUE FERMET. AIR	NR	1,50		
10		R1012080 BOITE ENTREE AIR ASSEMB	NR	20,80		
71		R1012700 MOTORED. MELLOR 2,0RPM FB1305	NR	104,00		
0		R1014820 PK EVO PLAQUE FIX. DEFL. AIR	NR	1,43		
86		R1014839 PLAQUE FERMET.PRISE	NR	2,50		
59		R1019780 RESISTANCE CERAMIQUE FKK PSX-2	NR	59,00		
116		R1024550 CONDENS 2UF P2 400V C FAS	NR	5,20		
89		R1028980 PK- SUPPORT ETRIER MICRO	NR	3,12		
91		R1029290 PLK JOINT SILIC HAUTE TEMP	NR	5,20		
73		R1029800 JOINT VENT. D.92-130 SILICONE	NR	5,20		
173		R1031110 FLANGE D.150 POUR CANALISATION	NR	7,28		
67		R1034030 TUBE PITOT	NR	2,08		
0		R1034110 PRISE USB PANNEAU UB-UB-50	NR	5,20		
60		R1035920 VENT.EVAGOLD30CO001-W925300030	NR	72,80		
0		R1037510 PK EVO SUPPORT SOUTIENT CABLE	NR	1,79		
90		R1037540 PELLKAMIN FLANGE TUYAU JOINT	NR	15,60		
3		R1041770 SONDE FUMEEES J CPF5 2-115	NR	15,60		





















PELLKAMIN EVO 8

HotSpot ↑↓	Basket Code ↑↓	Description	↑↓ Unité de mesure	Price €	Image	Note fra 2
21	 R1042380	VIS UNI 7379 D.6 L.40	NR	1,14		
47	 R1042400	RESSORT SECURITE SUR PRESSION	NR	1,04		
79	 R1043019	PANNEAU FERMETURE GAUCHE	NR	14,61		
80	 R1043029	PANNEAU FERMETURE DROITE	NR	17,36		
61	 R1057090	EXTR.FUMEEES CAF15Y-025PSH	NR	187,20		
22	 R1058210	VIS AUT TCL TLR S PUN 2.9X6.5	NR	0,05		
170	 R1060140	PLK12 TRAPPE CHARGEMENT PELL	NR	124,80		
0	 R1065870	JOINT SILIC D.58 68 H10	NR	10,40		
23	 R1066670	VIS AUT ZIG TCR FR SP 4,2X9,5	NR	0,06		
24	 R1066960	VIS TCL C CAVA HEXAG F.DI 6X20	NR	0,26		
25	 R1067170	VIS BRUN TRILOB TCL 6X16	NR	0,52		
69	 R1082740	SONDE NIV.CAPACITIF AVEC CONN.	NR	40,00		
50	 R1095000	RESSORT FIXAT BOUGIE	NR	0,50		
172	 R1096730	TUYAU FLEX D.150 L 120 CM	ML	43,80		
27	 R1115610	RADIOCOMMANDE MIND REMOTE	NR	221,00		
0	 R1118410	CAPT.SENSIRION SDP810- 500PA	NR	31,00		
28	 R1119410	TUYAU SPIRALE PA12 L 333 MM	NR	23,20		
19	 R1119700	PLK EVO- ENTREE AIR VERN	NR	35,36		
94	 R1119710	PK EVO PORTE VACUOMETRE	NR	3,61		
0	 R1119720	PK EVO CARTER PREMIER PROTECT.	NR	15,61		





















PELLKAMIN EVO 8

HotSpot ↑↓	Basket Code ↑↓	Description	↑↓ Unité de mesure	Price €	Image	Note fra 2
103	 R1119730	PK EVO SUPPORT FIXA. BRIDE V	NR	6,38		
0	 R1119740	PK EVO BOX DE CANALISATION	NR	50,52		
159	 R1119750	PK EVO SUP. VENTILATEUR CANAL	NR	5,20		
149	 R1119780	PK EVO FERMEVITRE PORTE GAUCHE	NR	4,00		
150	 R1119790	PK EVO FERMEVITRE PORTE DROIT	NR	4,51		
74	 R1121020	PK EVO BORNIER 20 BROCHES	NR	1,62		
62	 R1121150	MYA-RESSORT FIXATION MICRO	NR	3,33		
29	 R1121500	TUBE SILICONE 4X8 18 GR.X ML	ML	2,00		
51	 R1122789	PLAQUE FIXATION SONDE NIVEAU	NR	1,42		
105	 R1124400	PK EVO SUPPORT CARTE	NR	5,79		
17	 R1124430	PLK EVO-RESERVOIR RIVET	NR	47,53		
131	 R1124440	PLK EVO SUPPORT VITRE PEINT	NR	10,61		
130	 R1124450	PK EVO FACADE AVANT VITRE	NR	60,23		
12	 R1124460	PK EVO FACADE AVANT VITRE	NR	74,00		
16	 R1124510	PK EVO FACADE AVANT FICTIF	NR	37,10		
104	 R1124530	PK EVO PAROI POSTER.RESERVOIR	NR	13,59		
95	 R1124540	PK EVO PANNEAU FERMETURE POST.	NR	18,64		
96	 R1124550	PK EVO PANNEAU FERMETURE SUP..	NR	23,89		
0	 R1124560	PK EVO PROTEC. RESERV. PELLET	NR	11,11		
8	 R1124600	CABLAGE PELLKAMIN 8 10 EVO P	NR	68,00		





















PELLKAMIN EVO 8

HotSpot ↑↓	Basket Code ↑↓	Description	↑↓ Unité de mesure	Price €	Image	Note fra 2
112	 R1124640	PK EVO CAISSON FUME SOUDE	NR	49,38		
7	 R1124690	PK EVO PORTE CREUSET	NR	31,08		
0	 R1124710	PK E SUPPORT TUBE CHARGE PELLE	NR	18,11		
171	 R1124750	CADRE EXTERNE PK10 EVOPLUS	NR	114,31		
174	 R1124760	PK EVO PROF.INF.CADRE A PLI	NR	16,43		
30	 R1128680	VIS ZIN.AUT-TCL-TCR-SP 2.9X13	NR	0,04		
0	 R1130950	PK E JOINT CLAPET A EXPLOSIO	NR	3,94		
0	 R1130960	PLAQUE ANTI DETONATION	NR	2,23		
36	 R1132740	PLK12EVO PART SUP.CREUSET	NR	8,83		
136	 R1132840	PK EVO PORTE SOUDE	NR	14,38		
100	 R1132900	PLK E-JOINT ADHESIF C.CERAMIQ.	NR	1,38		
0	 R1132930	CARTER DE PROTECTION PRIMAIRE	NR	24,65		
11	 R1132970	PK EVO PLAQUE SUPPORT INSERT	NR	164,02		
97	 R1133050	PK EVO PROFILE INF. CADRE	NR	7,42		
114	 R1133060	PLK E-PLAQUE EPAISSEUR BOX FUM	NR	5,75		
0	 R1133079	PK EVO CADRE EXTERNE	NR	0,26		
180	 R1133130	PLK E-CADRE POUR KIT TIROIR	NR	19,14		
181	 R1133900	PK E TIROIR PELLET	NR	199,16		
0	 R1134080	PK E LAMELLE AIR 2	NR	1,54		
0	 R1134090	PK EVO LAMELLE AIR 3	NR	1,20		





















PELLKAMIN EVO 8

HotSpot ↑↓	Basket Code ↑↓	Description	↑↓ Unité de mesure	Price €	Image	Note fra 2
118	 R1137250	PRISE PRESS.POELE OUVERT	NR	3,21		
63	 R1137710	CHAUSSE FIBREVITRE D14-250 MM	NR	2,00		
0	 R1137750	JOINT ADHESIF BIOFELT	ML	7,00		
26	 R1137880	CARTE MERE RECHQ.MIND M.LAYER	NR	190,00		La carte electronique est vierge;pour qu elle fonctionner correctement,elle doit être programmee
70	 R1140400	PANNEAU URGENCE MIND INS.BLK	NR	77,00		
76	 R1140730	PELLKAMIN ENS CHARNIERE SUP	NR	3,31		
158	 R1148500	VENT CENTR.400 M3 H	NR	166,00		
102	 R1154970	CABLE FLAT SYNOPTIQ 6VIE L1500	NR	3,93		
123	 R1155260	PLK EVO RALLONG.PRISE PRESSION	NR	2,50		
13	 R1159750	PLK E-ENS PORTE ASSEMBLEE	NR	223,84		
31	 R11680	ECROU M6	NR	0,02		
75	 R1168470	PLK10EVO- ENS.CHARNIÈRE INF.	NR	1,11		
135	 R1183800		NR	4,19		
32	 R11860	VIS T.E ZINC 6x20 8.8	NR	0,06		
33	 R164450	GARNITURE TRICOTEE D 7W GR.18	ML	0,64		
34	 R168260	VIS AUT TCL 4.2X13	NR	0,02		
0	 R169180	VIS TETE HEXAG. 6X16	NR	0,06		
137	 R173050	GARNITURE.FIBR.8X2 NOIRE	ML	3,00		
142	 R178490	RONDELLE À RESSORT	NR	0,17		
155	 R188140	GARNITURE.FIBR.8X1 NOIRE ADHES	ML	3,00		

PELLKAMIN EVO 8

HotSpot ↑↓	Basket Code ↑↓	Description	↑↓ Unité de mesure	Price €	Image	Note fra 2
38	 R195700	VIS TT BOMB HEXAG INT M3X10	NR	0,05		
39	 R199040	TUBE SILICONE 4X8 18 GR.X ML	ML	2,18		
0	 R201070	VIS TCL C HEX 6X16	NR	0,05		
143	 R214930	ECROU TRILOBE M6	NR	0,10		
144	 R224660	GARNITURE.ARTICA GRISE D.13	ML	4,00		
42	 R232580	DOUILLE VERROUILLAGE MOTOREDC	NR	2,08		
48	 R234580	VIS INOX TCL CAV HEX 6X20	NR	0,16		
49	 R235990	VIS AUT TCL TCR S PUN 4,2X6,5	NR	0,05		
43	 R247330	DEMICOQUILLE SUP ZING CHARGEUR	NR	3,12		
44	 R247480	FERMET SUPER ZINGUEE CHARGEUR	NR	1,04		
52	 R254700	VIS TCL CAV HEX 6X20	NR	0,52		
53	 R254770	VIS TCL C CAV HEX 5X16	NR	0,04		
54	 R254790	RIVET 4X7 ACIER ACIER	NR	0,05		
0	 R260040	VIS AUT TCL TCR C PUN 4,2X9,5	NR	0,03		
55	 R266940	VIS AUT TCR TB S.P.FR 4,8X10	NR	0,10		
56	 R269080	INSERT M6X22 HEX	NR	0,50		
0	 R271330	RIVET 4,8X10 ACIER ACIER	NR	0,10		
0	 R284380	VIS TT BOMB EXAG INT M6X12	NR	0,05		
57	 R29600	VIS AUT TCL TCR S PU.4,2X9,5	NR	0,07		
58	 R29610	RONDELLE DENTE D5	NR	0,02		

PELLKAMIN EVO 8

HotSpot ↑↓	Basket Code ↑↓	Description	↑↓ Unité de mesure	Price €	Image	Note fra 2
157	 R299520	JOINT ADHESIVE 10X10 SOLEIL	ML	0,94		
93	 R5591A30	PK PLAQUE ECHANGEUR AVEC JOINT	NR	48,35		
98	 R5591A33	PK EVO GRILLE DE CREUSET FENTE	NR	39,23		
106	 R58190	VIS AUT TCL TCR BRUN 3,9X9,5	NR	0,05		
107	 R59630	VIS AUT TCL TCR BRUN 4.8X16	NR	0,05		
117	 R602050	ETRIER 12 POSITION	NR	5,00		
0	 R604000	ATTACHE A SELLE 9901-AA00	NR	0,52		
132	 R632490	ÉCROU PAPILLON M6	NR	0,11		
2	 R642680	POIGNÉE MAIN FROIDE	NR	18,00		
1	 R642760	CHERIE ENSEM.ACCROCHAGE POIGNE	NR	4,89		
45	 R646660	JOINT CHAUDI TUYAU FUMES	NR	2,00		
46	 R648590	JOINT PAPIER CHARGEUR	NR	1,04		
64	 R655290	MICROSWITCH-VRSRO1AA1AC14	NR	7,28		
156	 R664320	TINY ETRIER FIXATION VENTILAT.	NR	7,60		
108	 R674900	VIS ZING TRILOB TCL 6X12	NR	0,16		
0	 R678920	QUEBEC-COLLIER TUYAU D40-60	NR	2,08		
145	 R680290	PIVOT FIXATION PORTE CHERIE	NR	2,08		
151	 R692250	VIS M5X5 ZN NIC FI	NR	0,16		
109	 R69670	VIS INOX TCL EXAG 6X12	NR	0,21		
65	 R744600	SUPPORT HUBA CONTROL TYPE 605	NR	0,52		

PELLKAMIN EVO 8

HotSpot ↑↓	Basket Code ↑↓	Description	Unité de mesure ↑↓	Price €	Image	Note fra 2
0	 R752760	VIS TBC MET ZN M6X20 TRI	NR	0,21		
110	 R753630	VIS PAILLON M6X15 ZING NOIRE	NR	1,04		
120	 R772230	PRESSE CABLE MAXIBL PG7 ECROU	NR	1,56		
66	 R799830	PRESS HUBA TYPE 605 30PA	NR	20,80		
111	 R84170	VIS INOX TE5X10	NR	0,10		
119	 R85840	RONDELLE DENTE D6	NR	0,02		
133	 R8710	RONDELLE PLATE D6X18X1.5 ZB	NR	0,03		
113	 R8750	ECROU M8	NR	0,02		
146	 R920610	KIT REMPLACEMENT VITRE P KAMIN	NR	170,44		
87	 R920612	KIT ACTIVATION MICRO	NR	12,00		
147	 R920615	KIT PARCLOSE PLK 8EVO 10EVO	NR	18,83		
72	 RC00111	NEA-ROND.EST. FIXATION VITRE	NR	0,30		
68	 RC00185	PATTE DE TERRE 6 FASTON	NR	1,04		
0	 RPR558554	PK CAISSON AIR	NR	11,47		