

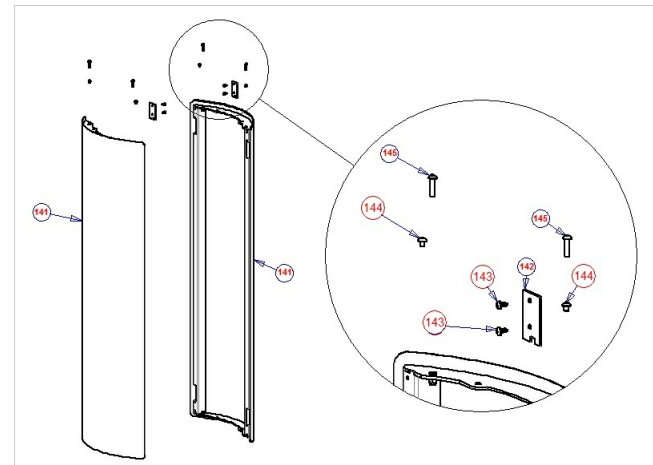

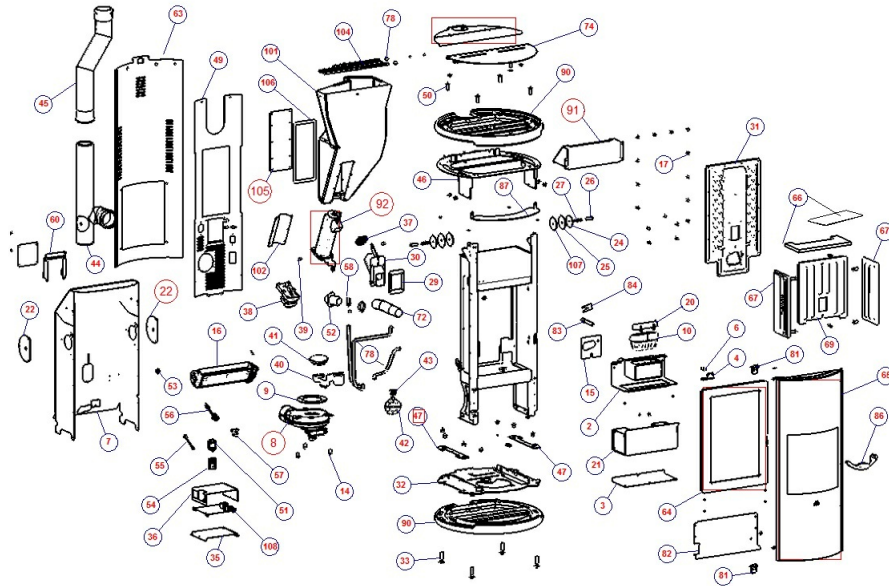























EVIA



EVIA

 		Code 	Description 	Unité de mesure	Price €	Image	Note fra 2
92		R1000000	CHARGEUR PELLETT DROIT	NR	66,49		
127		R1012770	MITO IDRO- PORTE EN FONTE	NR	55,00		
55		R1018900	CABLE SOS LM2-PS-70	NR	8,32		
67		R1019530	NARA COTE FOYER FONTE	NR	20,80		
83		R1019780	RESISTANCE CERAMIQUE FKK PSX-2	NR	59,00		
10		R1020200	NARA CREUSET EN FONTE	NR	10,40		
128		R1020660	VITRE CERAMIQUE 313X485X4	NR	41,60		
4		R1020710	NARA CHARNIERE SUP PORTE	NR	3,12		
3		R1020730	NARA PLAQUE FERMET FUME INFER	NR	3,17		
21		R1020740	NARA BAC A CENDRE	NR	18,72		
15		R1020780	GARN.PAPIER PORTE CREUSET NARA	NR	1,20		
135		R1020810	NARA-ARRET VITRE SUPERIEUR	NR	5,20		
16		R1021410	VENT TANG TRIAL THS30B5-055	NR	62,40		
33		R1021440	PIED D20 M8X57	NR	1,04		
134		R1021600	NARA-ARRET VITRE INFERIEUR	NR	8,32		
121		R1022070	ETRIER ANTIROTATION MOTORED	NR	5,82		
122		R1022080	JOINT BRANCHEMENT MOTORED	NR	2,60		
102		R1022090	DEMI COQUILLE SUP ZING CHARGEU	NR	4,16		
118		R1022120	CHARGEUR DROIT CORPS SOUDE	NR	25,88		
123		R1022140	ROULEMENT IGLIDUR GFM1416-06	NR	1,04		



EVIA

 		Code 	Description 	Unité de mesure	Price €	Image	Note fra 2
138		R1023509	NARA-EPAISSEUR INOX PASSAG.AIR	NR	0,34		
56		R1025940	SONDE AIR PG7 SP-NTC-65	NR	8,32		
36		R1027630	COUVERCLE CARTE HOTTOH	NR	3,12		
84		R1028579	PLK12 ETRIER FIXATION RESISTAN	NR	0,37		
35		R1030710	BASE METALLIQUE CARTE HOTTOH	NR	5,20		
51		R1031270	MODULE RADIO HOTTOH AVEC CABLE	NR	52,99		
		R1031310	SONDE FUMES J CPF5 2-60	NR	12,48		
58		R1034030	TUBE PITOT	NR	2,08		
20		R1034080	NARA PAREFEU INOX	NR	13,17		
57		R1034110	PRISE USB PANNEAU UB-UB-50	NR	5,20		
133		R1036440	JOIN FI.V. TRICOTTE N10 D13	ML	2,08		joint porte
38		R1036610	MOTOR MERKLE 2RPM CW HALL	NR	98,80		
125		R1041100	VIS TE 5X16 FRENAFIL BLEU	NR	0,21		
26		R1042380	VIS UNI 7379 D.6 L.40	NR	5,20		
27		R1042400	RESSORT SECURITE SUR PRESSION	NR	1,04		
24		R1044990	DAISY DISQUE ANTIEXPLOSION	NR	1,48		
25		R1053250	JOINT VANNE ANTIEXPLOSION	NR	2,76		
40		R1056810	NARA PLUS-SUP.PRESSOVACUOMETRE	NR	4,23		
22		R1057259	NARA PL-PLAQUE VANNE ANTIEXPLO	NR	1,35		
37		R1058220	JOINT 40 50 CHARG PELLETT	NR	5,20		





EVIA

 		Code 	Description 	Unité de mesure	Price €	Image	Note fra 2
129		R1059420	ENS VERROU	NR	5,20		
12		R1066670	VIS AUT ZIG TCR FR SP 4,2X9,5	NR	0,06		
119		R1067923	VIS sans fin 4 alettes	NR	20,80		
31		R1071600	PAROI ECHANGEUR PORT. FONTE	NR	63,00		
30		R1071670	KV L ENS TUYAU DESCENTE PELLETT	NR	21,84		
29		R1072080	JOINT DESCENTE PELLETT 50	NR	1,56		
90		R1073090	EVIA-BASE ET TOP	NR	90,00		
69		R1073100	FOND FOYER FONTE	NR	31,20		
110		R1073490	EVIA-VITRE PORTE EXTERNE	NR	115,00		
107		R1080320	JOINT POUR VANNE ANTI EXPLOSION	NR	0,80		
45		R1080340	TUY.SORTI FUMMES D80X726 F-F	NR	50,00		
44		R1080350	TUY.SORTI FUMMES A 90 ET INSP	NR	65,00		
141		R1080390	EVIA-ENS.FLANC ACIER BRONZE	NR	117,73		
141		R1080400	EVIA-ENS.FLANC ACIER NOIR	NR	111,25		
63		R1080490	EVIA-CALANDRE ARRIERE	NR	47,13		
142		R1080500	EVIA-PLAQUETTE COUVRE FLANC	NR	0,94		
91		R1080530	CONVOYEUR SUP. FRONTAL	NR	25,00		
7		R1080590	EVIA-CONVOYEUR D AIR	NR	42,29		
49		R1080610	EVIA-PANNEAU ARRIERE	NR	26,75		
60		R1080640	EVIA-SUPPORT PLAQUETTE	NR	5,95		







EVIA

 		Code 	Description 	Unité de mesure	Price €	Image	Note fra 2
111		R1080680	EVIA- PROF. GAUCHE FIXATION VITR	NR	9,10		
112		R1080690	EVIA- PROF. DROIT FIXATION VITRE	NR	9,62		
		R1080740	CHARNIERE PORTE EXT.	NR	45,00		
32		R1080780	EVIA- ENS. BASE METALLIQUE	NR	51,18		
47		R1080790	EVIA- ENS. SUP. INF. REGL. FLANC	NR	6,74		
147		R1080820	EVIA- ENS COUVERCLE PELLET	NR	21,84		
74		R1080830	EVIA- ENS. COUVERCLE FRONTAL	NR	24,14		
146		R1080840	EVIA- ENS. COUV. TOP CONDUIT FUM.	NR	45,81		
52		R1080860	EVIA- ENS. TUY. ENTREE AIR EXTERN	NR	19,56		
109		R1080870	EVIA- CADRE PORTE EXTERNE	NR	123,29		
65		R1080880	EVIA- PORTE EXTERNE	NR	284,18		
46		R1080890	EVIA- ENSEMBLE SOUS LE TOP	NR	61,89		
101		R1080900	EVIA- ENS. RESERVOIR PELLET	NR	105,00		
2		R1080910	EVIA- ENS. PORTECREUSET	NR	68,00		
104		R1080930	EVIA- GRILLE PROTEC. RESERVOIR	NR	6,00		
105		R1080999	PLAQUE POST. FERMETURE RESERVOI	NR	5,00		
87		R1081010	EVIA- DEFLECTEUR SUPERIEUR	NR	8,64		
82		R1081050	EVIA- ENS. FERM. INF. AVEC INSERT	NR	12,25		
64		R1081100	EVIA- PORTE AVEC VITRE FOYER	NR	143,00		
		R1081110	EVIA- COUVERCLE TOP POSTERIEUR	NR	54,33		

EVIA

 		Code 	Description 	Unité de mesure 	Price €	Image	Note fra 2
115		R1081180	PLAQUE SUPERIEURE PORTE EXTERN	NR	10,00		
108		R1093370	CARTE ELECT. HOTTOH HYD. UNIVE	NR	156,00		
8		R1095230	EXTR.FUMEEES PL21-W931210571	NR	150,00		
141		R1095250	EVIA FLANC BLANC	NR	110,00		
		R1095260	JEU COMPL ACIER BLANC FLANCS	NR	250,00		
141		R1095300	FLANC ROUGE R- 3001	NR	115,00		
		R1115620	RADIOCOMMANDE PHOENI CLE USB	NR	150,00		
19		R11960	RONDELLE D 5X10X1 ZINGUE	NR	0,01		
132		R162470	RONDE ONDULE D8	NR	0,04		
28		R164450	GARNITURE TRICOTEE D 7W GR.18	ML	0,64		
136		R173050	GARNITURE.FIBR.8X2 NOIRE	ML	3,00		joint vitre
106		R188140	GARNITURE.FIBR.8X1 NOIRE ADHES	ML	3,00		joint porte
68		R196990	VIS INOX TCL EXG 6X25	NR	0,31		
78		R199040	TUBE SILICONE 4X8 18 GR.X ML	ML	2,18		
39		R201070	VIS TCL C HEX 6X16	NR	0,05		
59		R211430	VIS ZING AUT TCL TCR 2.9X19	NR	0,05		
77		R216510	CAOUTCHOUC EN SILICONE	NR	0,50		Caoutchouc pour support top ceramique
124		R234420	BOUCHON EN CAOUTCHOUC POUR MOT	NR	1,50		
14		R234580	VIS INOX TCL CAV HEX 6X20	NR	0,16		
120		R247380	GARNITURE CARTE CERAMIQUE CHAR	NR	0,83		

EVIA

		Code 	Description 	Unité de mesure	Price €	Image	Note fra 2
53		R255360	THERMOSTAT REARMEMENT AUTOMATI	NR	7,28		
144		R27050	VIS TETE RONDE BOMBEE HEXAGONA	NR	0,52		
11		R274110	VIS TCL EXAG 6X35	NR	0,10		
145		R274630	VIS EXAG M5X20	NR	0,05		
143		R29600	VIS AUT TCL TCR S PU.4,2X9,5	NR	0,07		
6		R297850	PIVOT 5X20 UNI 1710 NOIR GALV.	NR	1,04		
85		R604000	ATTACHE A SELLE 9901-AA00	NR	0,52		
41		R640690	VACUOMETRE	NR	53,00		
130		R642240	PIVOT FIXATION PORTE CHERIE	NR	2,08		
		R642560	PEIN.SIL.LOW SMOKE NOIR 390318	KG	35,00		
86		R642680	POIGNeE MAIN FROIDE	NR	18,00		
71		R646880	QUEBEC-COLLIER TUYAU D40-60	NR	2,08		
72		R666870	TUYAU FLEXIBLE D.40 711VN140E	ML	31,20		
9		R669090	JOINT PAPIER LIMACON TINY	NR	1,56		
17		R674900	VIS ZING TRILOB TCL 6X12	NR	0,16		
18		R681370	VIS M6X25	NR	0,26		
50		R682800	VIS TBC MET ZN 6X35 TRI	NR	0,31		
54		R684940	PRISE COURANT FUS FASTON	NR	8,32		
70		R741030	VIS TCL EXAG 5X10	NR	0,06		
43		R744600	SUPPORT HUBA CONTROL TYPE 605	NR	0,52		

EVIA

 	Code 	Description 	Unité de mesure	Price €	Image	Note fra 2
73 	R746540	AIMANT RMB-ND13-M5	NR	6,24		
131 	R75210	VIS AUT TCL TCR BRUN 3.9X6.5	NR	0,03		
13 	R753900	DOUILLE D.8X6,1X16	NR	0,52		
42 	R799830	PRESS HUBA TYPE 605 30PA	NR	20,80		
76 	R86480	RONDELLE PLATE D.5X20	NR	0,04		
48 	R8710	RONDELLE PLATE D6X18X1.5 ZB	NR	0,03		
	R8880	ECROU M5	NR	0,01		
149 	R917865	VIS TT BOMB HEX INT M5X16	NR	0,16		
66 	R920547	KIT 2 deflecteurs NARA2 scamol	NR	20,00		
34 	RC00185	PATTE DE TERRE 6 FASTON	NR	1,04		
	RPC2483	VIS-SUPPORT ESTHET. EVIA	NR	6,00		