

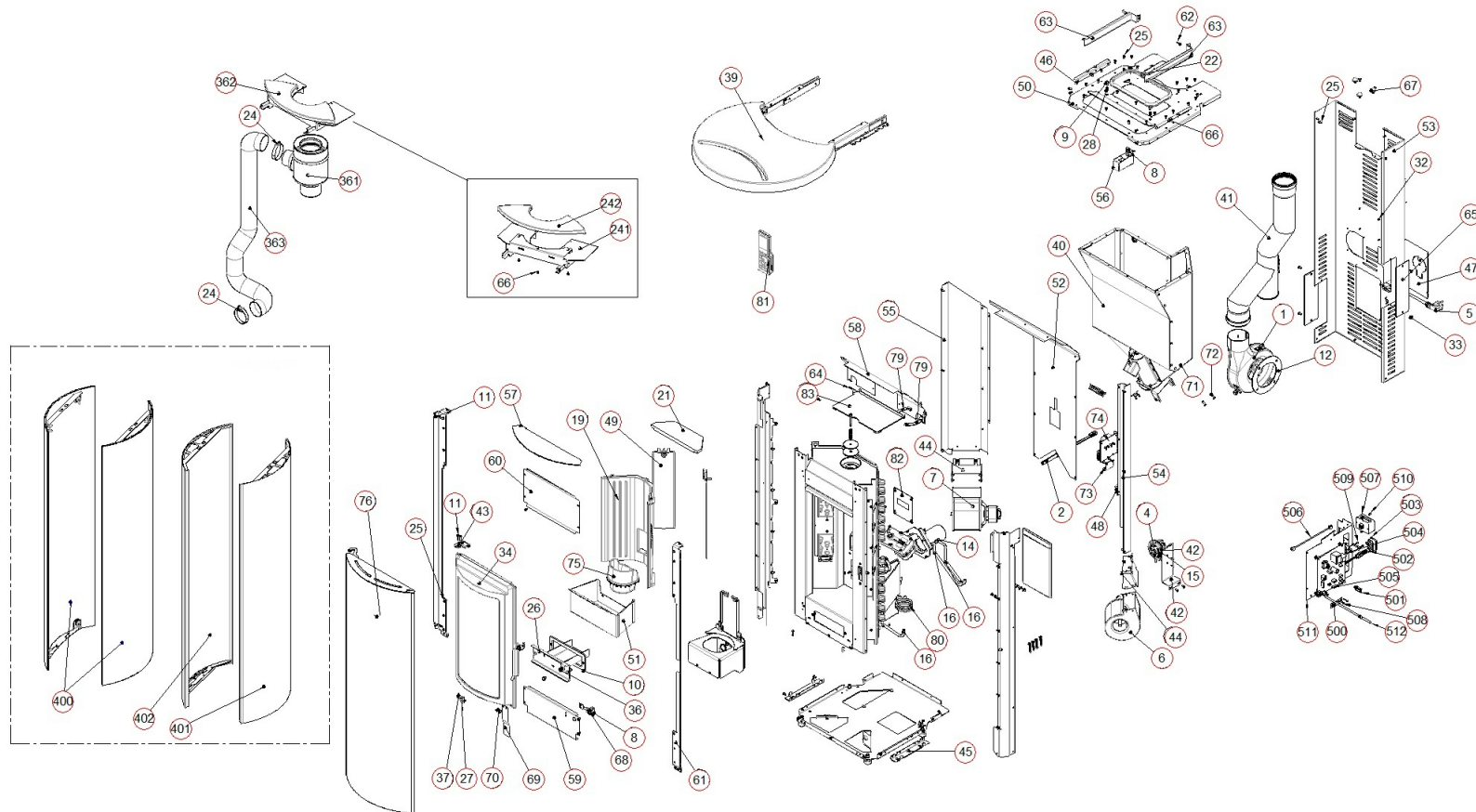

























CELIA ATC



















CELIA ATC

 		Code 	Description 	Unité de mesure	Price €	Image	Note fra 2
212		R1007710	PORTE INTERNE EN FONTE	NR	57,14		
34		R1007820	ANIA PORTE INTERNE	NR	230,47		
216		R1007850	DEFLECT.NETTOYAGE VITRE ASSEM	NR	10,40		
211		R1009680	ANIA PROF.SUPP. VITRE INOX	NR	4,16		
43		R1009720	ANIA PLAQUE CHARN.INTERIEUR	NR	3,76		
213		R1013270	ANIA VERROU	NR	5,80		
118		R1016880	INSERT CONNEXION VACUOMETRE	NR	1,10		
4		R1017420	CABLE ALIM H05RR-F L 1,5	NR	7,28		
512		R1031310	SONDE FUMES J CPF5 2-60	NR	12,48		
14		R1034030	TUBE PITOT	NR	2,08		
504		R1034110	PRISE USB PANNEAU UB-UB-50	NR	5,20		
42		R1034330	SUPPORT VACUOMETRE	NR	2,62		
500		R1041220	AUTOCOLLANT POUR BORNIER 12P	NR	1,50		
502		R1041750	SONDE AIR PG7 MM2 NTC 100	NR	10,40		
110		R1042380	VIS UNI 7379 D.6 L.40	NR	5,20		
111		R1042400	RESSORT SECURITE SUR PRESSION	NR	1,04		
1		R1057090	EXTR.FUMES CAF15Y-025PSH	NR	187,20		
29		R1058210	VIS AUT TCL TLR S PUN 2.9X6.5	NR	0,05		
13		R1058220	JOINT 40 50 CHARG PELLETT	NR	5,20		
363		R1063100	TUB FLEX D63 711.VN1 AL MT	ML	43,68		



CELIA ATC

 		Code 	Description 	Unité de mesure	Price €	Image	Note fra 2
33		R1066670	VIS AUT ZIG TCR FR SP 4,2X9,5	NR	0,06		
130		R1067160	JOINT COUVERCLE ANTI-EXPL.	NR	5,20		
100		R1076030	GUIDES TOP PELLETT pair	NR	9,50		
28		R1077000	INSERT M5X12 HEX T RID	NR	0,20		
117		R1077499	PRISE TUY.VACUOM.P2 SUR FOYER	NR	0,50		
131		R1081150	DISQUE ANTIEXPLOS	NR	3,32		
503		R1082370	PRISE SECTEUR LUM.AVEC INTER.	NR	6,00		
22		R1100290	JOINT RESERVOIR	NR	6,00		
361		R1101290	RACCORD COAXIAL 80 130-60M	NR	116,81		
19		R1102590	DANIA - FONTE FOYER GAUCHE	NR	31,09		
20		R1102600	DANIA- FONTE FOYER DROITE	NR	29,43		
103		R1102610	TOP FONTE COULISSANT	NR	87,75		
242		R1102620	CELIA- TOP POSTERIEUR EN FONTE	NR	14,08		
75		R1102630	CREUSET AVEC PARE FEU	NR	18,00		
206		R1102710	VITRE PORTE EXTERNE	NR	113,15		
140		R1105600	Pied PE NOIR Ø26 H15	NR	2,52		
112		R1109880	ECHANGEUR POST ASSEMBLE	NR	20,33		
2		R1112630	BOUGIE CERAMIQUE PSX-1-240-B	NR	48,03		
68		R1112640	RESSORT FIXATION MICROINTERRUP	NR	0,00		
78		R1112700	MOTORED.MERKLE 1,1 RPM-CW HALL	NR	85,00		

CELIA ATC

 	Code 	Description 	Unité de mesure 	Price €	Image	Note fra 2
121	 R1112920	TUYAU PRISE D AIR	NR	48,82		
123	 R1112970	COLLECTEUR FUMeE	NR	63,29		
132	 R1113030	SUPPORT FIXATION BOUGIE	NR	2,45		
120	 R1113060	PORTE CREUSET	NR	49,94		
119	 R1113230	CHAMBRE DE COMBUSTION	NR	285,36		
128	 R1113240	PLAQUE FIXATION POIGNEE	NR	2,81		
10	 R1113450	JOINT DANIA EPAISSEUR 5MM	NR	2,44		
21	 R1113460	DANIA-DEFLECTEUR FUME VERMICUL	NR	6,27		
47	 R1113480	PLAQUE D INSPECTION POSTERIEUR	NR	8,37		
49	 R1113510	SUPPORT FONTE INTERNE FOYER	NR	7,12		
45	 R1113530	SUPPORT FIXATION FLANC	NR	3,97		
44	 R1113540	PIECE POUR AIR VENTILATION	NR	5,26		
511	 R1113550	DANIA SUPPORT CARTE ELECTRONIQ	NR	5,87		
46	 R1113920	SUPPORT FIXATION FLANC	NR	2,00		
48	 R1113940	RESSORT POUR BOUGIE	NR	3,09		
122	 R1113980	BASE AVEC PIEDS	NR	52,27		
124	 R1113990	MONTANT STRUCT.FRONTALE DROITE	NR	21,12		
125	 R1114000	MONTANT STRUCT.FRONTALE GAUCHE	NR	22,21		
64	 R1114010	FERMETURE CARTER CENTRAL	NR	2,13		
133	 R1114040	FERMETURE INF.FONTE PEINTE	NR	10,75		











CELIA ATC

 		Code 	Description 	Unité de mesure	Price €	Image	Note fra 2
65		R1114470	COUVERCLE MANUTENTION LATERAL	NR	4,33		
241		R1114500	TOP POSTERIEUR ATC SOUDe	NR	40,19		
362		R1114540	TOP POSTERIEUR ATC ASSEMBLe	NR	59,11		
50		R1114560	CHASSIS SUPERIEUR	NR	37,81		
53		R1114570	CARTER POSTERIEUR	NR	76,24		
40		R1114630	RESERVOIR COMPLET	NR	78,89		
105		R1114640	SUPPORT FIXE POUR TOP	NR	4,59		
104		R1114650	SUPPORT COULISSANT POUR TOP	NR	3,92		
39		R1114660	TOP FONTE COULISSANT	NR	114,12		
202		R1114680	CELIA-CADRE PORTE EXT SOUDe	NR	96,05		
204		R1114730	CELIA-PROFIL FIX.VITRE GAUCHE	NR	10,24		
205		R1114740	PROFIL FIXATION VITRE DROITE	NR	9,33		
203		R1114760	COUVERCLE SUP.PORTE EXTERNE	NR	9,63		
76		R1114770	PORTE FOYER EXTERNE	NR	257,07		
38		R1114790	CELIA-PROFIL PORTE FOY.EXT GAU	NR	19,72		
507		R1115500	PANNEAU D URGENCE MIND	NR	56,57		
505		R1115520	CARTE ELECT.AIR CANALISe MIND	NR	170,00		
506		R1115540	CABLE FLAT SYNOPT.4 VOIES L250	NR	3,00		
81		R1115610	RADIOCOMMANDE MIND REMOTE	NR	128,21		
60		R1115640	COUVERCLE FRONTAL SUPERIEUR	NR	19,94		





















CELIA ATC

 	Code 	Description 	Unité de mesure 	Price €	Image	Note fra 2
54	 R1115650	CARTER AIR COTe DROIT	NR	11,32		
55	 R1115660	CARTER AIR COTE GAUCHE	NR	11,42		
52	 R1115670	CARTER AIR	NR	17,28		
37	 R1115690	CHARNIERE INF PORTE FOYER	NR	5,33		
56	 R1115700	FIXATION MICROINTERRUPTEUR	NR	3,72		
69	 R1115710	SUPPORT ACTIVATION MICRO	NR	3,69		
59	 R1115720	COUVERCLE FRONTAL INFERIEUR	NR	23,21		
51	 R1115730	TIROIR CENDRE	NR	20,84		
61	 R1115760	PROF.PORTE FOYER EXT DROITE	NR	14,01		
400	 R1115770	CELIA- FLANC VERRE BLANC	NR	218,25		
400	 R1115780	CELIA-FLANC VERRE NOIR	NR	185,36		
57	 R1115790	GRILLE SUPERIEURE	NR	5,47		
58	 R1115800	DEFLECTEUR AIR SUP	NR	6,85		
63	 R1115810	SUPPORT TOP POSTERIEUR	NR	14,69		
402	 R1115870	CELIA-FLANC NOIR FINIT .DROITE	NR	77,00		
401	 R1115880	CELIA-FLANC NOIR FINIT .GAUCHE	NR	77,00		
41	 R1115890	TUYAU SORTIE FUMeE	NR	105,82		
143	 R1116160	CELIA- BASE SANS PIED	NR	40,21		
73	 R1117280	SUPPORT FIXATION AIRKARE	NR	4,98		
74	 R1117300	BASE AIRKARE	NR	103,37		

CELIA ATC















		Code 	Description 	Unité de mesure	Price €	Image	Note fra 2
82		R1117530	COUVERCLE INSPECTION	NR	3,51		
79		R1117550	CENTRAGE TUYAU FUMEE	NR	3,30		
83		R1117610	COUVERCLE COUVERCLE	NR	20,08		
76		R1117620	CELIA-PORTE EXTERNE MAGIC	NR	284,34		
77		R1117630	EMBALLAGE TYPE B	NR	36,60		
80		R1119410	TUYAU SPIRALE PA12 L 333 MM	NR	23,20		
206		R1120410	CELIA-VITRE EXTERNE MAGIC	NR	140,42		
134		R11680	ECROU M6	NR	0,02		
214		R162470	RONDE ONDULE D8	NR	0,04		
207		R188140	GARNITURE.FIBR.8X1 NOIRE ADHES	ML	3,00		
101		R195640	VIS AUT TSV TCR BRUN 4,2x13	NR	0,05		
509		R195700	VIS TT BOMB HEXAG INT M3X10	NR	0,05		
16		R199040	TUBE SILICONE 4X8 18 GR.X ML	ML	2,18		
508		R211430	VIS ZING AUT TCL TCR 2.9X19	NR	0,05		
67		R234420	BOUCHON EN CAOUTCHOUC POUR MOT	NR	1,50		
66		R235990	VIS AUT TCL TCR S PUN 4,2X6,5	NR	0,05		
71		R253780	INSERT M5X20 HEXAG T RID	NR	0,40		
26		R254770	VIS TCL C CAV HEX 5X16	NR	0,04		
32		R254790	RIVET 4X7 ACIER ACIER	NR	0,05		
221		R260040	VIS AUT TCL TCR C PUN 4,2X9,5	NR	0,03		

CELIA ATC

 		Code 	Description 	Unité de mesure	Price €	Image	Note fra 2
141		R263690	INSERT M8X18 HEXAG	NR	0,25		
200		R27050	VIS TETE RONDE BOMBEE HEXAGONA	NR	0,52		
129		R272960	INSERT M6X16HEX T RID	NR	0,08		
126		R289340	VIS TCL C CAV HEXAG 6X45	NR	0,10		
25		R29600	VIS AUT TCL TCR S PU.4,2X9,5	NR	0,07		
145		R29610	RONDELLE DENTE D5	NR	0,02		
11		R297850	PIVOT 5X20 UNI 1710 NOIR GALV.	NR	1,04		
217		R425780	GARNITURE.ARTICA GRISE D.10	ML	4,00		
142		R56400	RONDE D8	NR	0,02		
30		R58190	VIS AUT TCL TCR BRUN 3,9X9,5	NR	0,05		
501		R604000	ATTACHE A SELLE 9901-AA00	NR	0,52		
215		R642240	PIVOT FIXATION PORTE CHERIE	NR	2,08		
8		R655290	MICROSWITCH-VRSRO1AA1AC14	NR	7,28		
12		R669090	JOINT PAPIER LIMACON TINY	NR	1,56		
27		R674900	VIS ZING TRILOB TCL 6X12	NR	0,16		
116		R691810	ecrou m4 zn avec collier	NR	0,03		
15		R744600	SUPPORT HUBA CONTROL TYPE 605	NR	0,52		
9		R746540	AIMANT RMB-ND13-M5	NR	6,24		
7		R748050	VENT CENT CAD07B-FA006-SX BOC	NR	95,00		
510		R75210	VIS AUT TCL TCR BRUN 3.9X6.5	NR	0,03		



CELIA ATC

 		Code 	Description 	Unitè de mesure	Price €	Image	Note fra 2
127		R753900	DOUILLE D.8X6,1X16	NR	0,52		
6		R756990	VENT CENT CAD07B-FA006M DROIT	NR	93,60		
4		R799830	PRESS HUBA TYPE 605 30PA	NR	20,80		
31		R86480	RONDELLE PLATE D.5X20	NR	0,04		
72		R8870	VIS T.E 5X14	NR	0,05		
201		R8880	ECROU M5	NR	0,01		
62		R917865	VIS TT BOMB HEX INT M5X16	NR	0,16		
115		RC00028	VIS TSV PIAN.TCR ZINC.NR.4X12	NR	0,05		
24		RC00120	COLLIER C VIS D50-70 CNS070	NR	1,56		
3		RC00185	PATTE DE TERRE 6 FASTON	NR	1,04		